

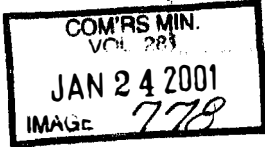

Sewer Tapper Test Study Guide

2017 Edition



ARTICLE II

CONTROL OF SEWERS

Section 201 Control

All public and private sanitary and combined sewers, and all private sanitary and combined sewers which discharge into public sewers, in the Metropolitan Sewer District service area shall be controlled by the Director.

Section 202 Ownership

All public or private sanitary and combined sewers shall continue to be owned by the respective public or private owners now owning same until such time as the owner and the Board mutually agree to a transfer of ownership to the Board.

Section 203 Approval of Construction

No public or private sanitary or combined sewer shall be constructed within the jurisdiction of the District without the prior written approval of the Director.

Section 204 Connection to WTS

Any connection to a public or private sanitary or combined sewer within the jurisdiction of the District shall be subject to these Rules and Regulations and to any charges, rates, fees and assessments which are or may be established by the Board as being applicable, and shall be made under permits issued by the Director.

Section 205 Extension or Modification

No extension or modification shall be made to any sanitary or combined sewer, controlled by the District, without the prior written approval of the Director.

Section 206 Construction of Structures Over Sewers

The policy of the Board of County Commissioners of Hamilton County (BOCC) regarding the construction of structures over public sewers and appurtenances and regarding the construction of public sewers and appurtenances beneath structures within the jurisdiction of MSD is as follows:

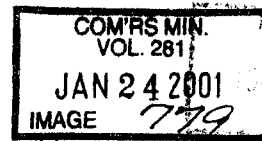

MSD will permit no structure of any kind which can interfere with access to a public sewer or exert loading upon a public sewer to be placed in or upon a permanent sewer easement, excepting items such as recreational surfaces, paved areas for parking lots, driveways, or other surfaces used for ingress or egress, plants, trees, shrubbery, fences, landscaping or other similar items, being natural or artificial.

MSD will permit no public sewer to be constructed beneath a structure of any kind which can interfere with access to the said public sewer or exert loading upon the said public sewer, excepting items such as recreational surfaces, paved areas for parking lots, driveways, or other surfaces used for ingress or egress, plants, trees, shrubbery, fences, landscaping or other similar items, being natural or artificial.

Any deviation from the aforesaid restrictions may be allowed only by BOCC. An owner may petition for an exception by written request to BOCC. Each such request shall be considered on an individual basis, and BOCC will grant any such exceptions by resolution.

Section 207 Sewer Easement Restrictions

All easements for public sanitary and combined sewers obtained or granted after September 13, 1978, shall be subject to the following restrictions:

No structure of any kind which can interfere with access to said public sewer shall be placed in or upon a permanent sewer easement, excepting items such as recreational surfaces, paved areas for parking lots, driveways, or other surfaces used for ingress and egress, plants, trees, shrubbery, fences, landscaping or other similar items, being natural or artificial. Any of the aforesaid surfaces, paved areas, plants, trees, shrubbery, fences, landscaping or other similar items which may be placed upon such said permanent easement shall be so placed at the sole expense of the property owner, and the grantees or assigns of any permanent easement henceforth shall not be responsible to any present owners of the property, nor to their heirs, executors, administrators or assigns, for the condition, damage to, or replacement of any such aforesaid items, or any other items placed upon the easement, resulting from the existence or use of the said permanent easement by the grantees or assigns.

Any structure constructed on said property in which said permanent sewer easement exists shall be kept not less than three (3) feet outside the permanent sewer easement line nearest the site of the proposed structure.

Any deviation from the aforesaid restrictions shall be petitioned by written request to the Board or their assigns. Each such request shall be considered on an individual basis.

Section 208 Infiltration/Inflow to Private Sewers

The owner of a private sanitary sewer shall be responsible for any future updates necessary to prevent excessive infiltration and/or inflow from entering the private sewer system.

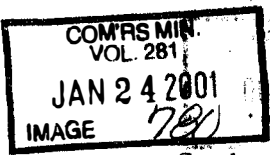

Section 209 Degree of Protection from Flooding

MSD does not guarantee protection from flooding to those consumers who connect to the public sewer system. Potential for flooding varies with the geographic location and elevation of the property served. Varying conditions may affect the operation and maintenance of the sewer mains, building connections, pump stations and other sewer system appurtenances. It is recommended that consumers and their representatives investigate and become aware of local sewer conditions and topography, laws, rules and regulations so that the desired degree of protection for new construction can be designed and achieved.

ARTICLE III

COMBINED SEWERS

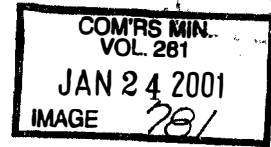

Section 301 Construction; Extension of Sewers

The construction of and/or extension to combined sewers are hereby prohibited, unless approved by the District.

Section 302 Connections to Combined Sewers

Except as may be modified by the Codes of the State of Ohio and the City of Cincinnati, Ohio, Basic building Code-Plumbing Code Section 1151-69, individual properties shall install a separation manhole at the junction of the building sewer-storm and building sewer-sanitary at the public right-of-way for the purpose of discharging combined wastes to a public combined sewer in accordance with Standard Drawing Acc. No. 49063.

In selected areas designated by the Director, separation for residential properties shall be provided for all new connections to the combined sewer systems. For residential properties, a "Y" connection and cleanout in accordance with Standard Drawing Acc. No. 49047 may be used in lieu of a separation manhole.

Section 303 Detention Requirements for Stormwater Connections or Modifications

Stormwater connections or modifications which involve stormwater ultimately tributary to the combined sewer system shall be subject to the District's Policy for Stormwater Detention Facilities, as specified below:

POLICY FOR STORMWATER DETENTION FACILITIES

- A. The volume of stormwater detained shall be the difference in runoff volume from the predeveloped site over a ten-year event of one hour duration and the postdeveloped site under a twenty-five year event of one hour duration. The peak rate of runoff from the site after development for a twenty-five year storm event of one hour duration shall not exceed the predevelopment site peak runoff for a ten-year event of one hour duration.
- B. Peak flow rates shall be determined by the Rational Method which is appropriate for small drainage areas.

The basic formula for the Rational Method is $Q = CiA$

Where Q is the peak rate of runoff in cubic feet per second, C is the runoff coefficient, and i is the



average intensity of a storm of given frequency for a selected duration in inches per hour, and A is the area in acres.

- C. The required storage volume, S, in cubic feet, for the detention facility shall be computed by the following:

$$S = V*(1-Q1/Q2)*1.15$$

where V = Q2*3600 is the volume of runoff and 1.15 represents a 15 percent safety factor which may be applied at the discretion of the District.

Q2 is the post development peak flow for a twenty-five year storm of one hour duration and Q1 is the predevelopment peak flow for a ten-year storm of one hour duration. Q1 is also the maximum allowable release rate at storage volume S.

The above equation reduces to the simplified form:

$$S = 4140(Q2 - Q1)$$

or S = 3630 (Q2 - Q1) without the safety factor.

- D. The applicable rainfall intensities for these storm events are provided below:

i = 2.03 inches/hour (ten-year)

i = 2.42 inches/hour (twenty-five year)

These rainfall intensities have been developed for Cincinnati from the latest precipitation data contained in the U.S. Department of Commerce Technical Memorandum NWS HYDRO-35 and Technical Paper No. 40, and supersede all previous work.

- E. Runoff coefficients (C-values) adopted for use in the Rational stormwater drainage in Cincinnati are provided below:

Runoff Coefficients
for the Rational Method

Land Use	Runoff Coefficient
Residential	0.5
Multi-family	0.6
Commercial and Business Districts	0.8
Industrial Districts	0.7

Open Space (parks, golf courses, cemeteries meadows, grass, woods, lawns, etc.)	0.3
Impervious Areas (parking lots, roads, rooftops)	0.9
Steep wooded hillside slope > 10 percent	0.5

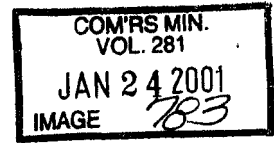

Composite Runoff Coefficients- If the runoff coefficient varies over a subarea, a composite coefficient can be calculated as an average, weighted by the area of the various runoff coefficients.

- F. All detention facilities shall provide a passive emergency discharge outlet which shall be used only when the required storage volume is exceeded.
- G. Stormwater detention facilities shall be private with operation, maintenance and associated liability thereof being the responsibility of the owner.

A stormwater detention pond or lake location must have its private storm drainage limits prepared by the Developer or his Engineer on a record plat by the metes and bounds description. The record plat is to be submitted to MSD for review and approval. The District shall have the plat recorded.

The said limit area and all improvements in it shall be maintained continuously by the Owner. No structures, planting or other material, shall be placed or permitted to remain which may obstruct, retard or change the direction of the flow of water through the drainage channel in the said limits.

Similar requirements shall apply for private storm basin easement limits when multiple owners are involved.

- H. Any waiver of or exception to these requirements shall be determined by the Director on a case-by-case basis.

For protection of the environment and downstream property, the District's detention requirements may be more restrictive in sensitive areas.

Responsibility for proper maintenance of detention facilities and appurtenances shall be with the property owner granted permission to make connection with the District's combined sewer system. It shall be the responsibility of any current or subsequent owner to transfer and record this responsibility should property ownership change.

Under no circumstances shall alterations affecting the volume, operation, or release rate be made without first obtaining written permission from the District.

Other governmental agencies may impose their own jurisdictional detention requirements providing the release rates and storage volumes meet or exceed those satisfactory to the District as determined by the Director.

Section 304 Amendments

October 1, 2003

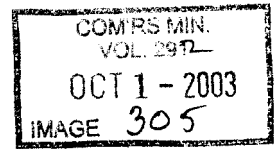

ARTICLE III COMBINED SEWERS

Section 304 Basement Flooding Problems In Areas Served By Combined Sewers

~~The policy of the Board allows for consideration of cost sharing between the Board and a local jurisdiction for improvements made in an area served by a combined sewer system to alleviate chronic basement flooding, as provided below:~~

The Director of the Metropolitan Sewer District shall identify to the Board of County Commissioners each project proposed for the reduction of combined sewer basement flooding, and he shall describe the project scope, its estimated total cost, and his recommendation for apportionment of costs among participating agencies. The Board shall approve in advance of any such project being undertaken.

The Director shall recommend only those projects where he has determined that the combined sewer contributes to chronic basement flooding.

The Director shall determine that the combined sewer does not presently have the capacity to convey the flow from a 10-year, 24-hour storm.

The basement flooding must be localized to a small area.

The improvement must significantly reduce the incidence of basement flooding.

The proposed project shall be the most cost effective alternative for the resolution of the chronic basement flooding problem.

~~The MSD share of the proposed improvement shall be less than 50%.~~

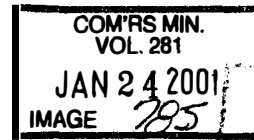

ARTICLE IV

USE OF THE WASTEWATER TREATMENT SYSTEM

Section 401 Unauthorized Discharge/Connection

No person shall discharge or cause to be discharged, either directly or indirectly, to the sanitary sewer system, surface water, foundation drains, groundwater, roof runoff, subsoil drains, subsurface drainage, cooling water, swimming pool water or unpolluted industrial process water as determined by the Director.

No water resulting from basement waterproofing solution methods shall be discharged to the sanitary sewer system directly or indirectly.

Should the owner of such an unauthorized connected premise fail to remove the unauthorized connection within ninety (90) days of being notified by the Director, the Director will issue a second violation notice giving the owner of the premises an additional 90 days to correct the violation and advising the owner that fines may be incurred commencing after thirty (30) days beyond the 90 day second violation period. After 30 days, third violation notices are sent advising the property owner that they may be incurring fines of up to \$100 per day accumulative until the violation is corrected.

Any such connection shall be considered unauthorized, and shall be subject to immediate removal by the owner of the premises so connected.

All removal costs shall be at the owner's expense, except as follows in specified areas: As authorized by the Ohio Revised Code Section 6117.012 and in accordance with the funded program for "District Funded Elimination of Improper Stormwater Inflows" as adopted by the Board of County Commissioners by Resolution dated January 2, 1992, the District may reimburse the participating owner of a premises up to a maximum of \$3,000 for corrective work to remove improper stormwater inflows which were in existence prior to April 12, 1968 or prior to the date such premises became under MSD jurisdiction.

Section 401-A Program for District-funded Elimination of Improper Stormwater Inflows

1. Purpose. The purpose of this Program is to reduce significantly improper stormwater inflows in the most cost-effective manner, in order to eliminate or reduce instances of surcharged sanitary sewers due to improper inflows, which are inimical to public health and welfare; and to maximize efficient operation of the District's wastewater treatment plants. "Improper stormwater inflows" as used in this Program include any kind of stormwater connection or inflow into the sanitary sewer system prohibited by MSD Rules and Regulations.
2. Eligible Participants. This Program may be utilized only for: (a) Improper stormwater inflows which were in existence prior to April 12, 1968 (the date of the agreement establishing MSD);



or, (b) for premises in areas which were included in the MSD at a later date, improper stormwater inflows which were in existence prior to the date of such inclusion. The reason for this limitation is to preclude implementation of this Program as to improper stormwater inflows established under MSD jurisdiction.

This Program may be implemented only in political subdivisions within the District in which building, health, or other codes prohibit future improper stormwater inflows.

3. Target Areas; Orders. The Director of MSD (the "Director") may implement and make available this Program throughout the District, or instead only in target areas within the District determined by the Director as having the highest priority for reduction of stormwater inflows based on surcharging problems. When the Director issues orders for removal of improper stormwater inflows in an area where the Program is being implemented, the Director shall inform the owner of the availability of the Program. Participation in the Program shall be voluntary; owners declining to participate shall be required to proceed with removal of the improper inflow at the owner's expense.
4. Scope of Work. The Director shall determine for each participating premises the scope of work for reduction of improper stormwater inflows which may be paid for with Program funds, with the goal of achieving the most cost-efficient and timely reductions. If work paid for under this Program does not eliminate every improper stormwater inflow for a participating premises, the Director is not precluded from issuing supplemental orders concerning such premises under Section 401 of the Rules and Regulations of MSD.

For each participating premises the maximum cost which may be paid with MSD funds shall be \$3,000. If additional work is required it shall be performed at owner expense.

5. Approved Contractors. The Director may establish a list of private contractors approved for performing work under this Program based on qualifications including experience, quality of work and insurance. Participating owners may propose additional contractors for inclusion in the approved list.
6. Contractor Selection. Participating owners shall select an approved contractor in accordance with a competitive process established by the Director. After MSD review and approval of the contractor selection and contract price, the owner shall contract with the selected contractor for performance of the approved scope of work. Neither the District nor the Board of County Commissioners shall be a party to such contract. The owner's contract shall specify that the owner's final payment to the contractor shall not be made until the work is inspected and approved by MSD and approved by the owner, and shall require the contractor to secure any building permits as may be necessary.

The Director may establish rules authorizing reimbursement or partial reimbursement for owner-performed work.

7. Release. As a condition to participation in the program the owner shall release the Board of County Commissioners, the City of Cincinnati, and their officers and employees from all liability relating to the work.

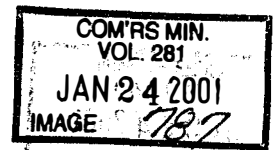

8. Payment. After the work is inspected and approved by MSD and approved by the owner the Director shall authorize payment for 100% of the cost of the approved work (subject to the \$3,000 maximum) from District funds appropriated to Capital Improvement Project No. 91-18. partial payments may be made. Payment may be made to the owner or jointly to the owner and contractor. No payments under this Program are subject to reimbursement by owners.
9. Maintenance. Participating owners shall be responsible for maintaining any improvements constructed under this Program.
10. Director Rules. The Director may establish such further criteria and rules as are required to implement this Program. In implementing this Program the Director is authorized to waive strict application of the requirement in section 401 of the Rules and Regulations of MSD whereby removal of unauthorized connections to the sanitary sewer system is to be performed at the owner's expense.

Section 402 Municipalities

No sanitary sewer or sanitary sewer system shall be constructed within any municipality, which connects either directly or indirectly to a wastewater treatment works controlled by the District, until such municipality has adopted an ordinance prohibiting any unpolluted waters therefrom and meeting the standards of these Rules and Regulations. It shall be the responsibility of each municipality to enforce the provisions of said ordinance. The Director may refuse to permit a connection, either directly or indirectly, to the wastewater treatment system by or within any municipality until that municipality adopts such an ordinance.

Section 403* Discharge of Polluted Waters

No person shall discharge or cause to be discharged to any natural outlet or storm sewer any sanitary sewage or other polluted waters. Effluent from privately owned individual household disposal devices, shall not be discharged to storm sewers.

- * Enforcement of this regulation is the responsibility of the several Boards of Health. Its appearance here is for informational purposes only.

Section 404 Discharge of Stormwater

Storm water and all other unpolluted drainage shall be discharged into such sewers as are specifically designed and designated as storm sewers or to a natural outlet where either is available in accordance with the requirements of the public jurisdictional authority. Said unpolluted drainage shall only be discharged to a combined sewer when a storm sewer or natural drainage course does not exist or is unavailable as determined by the District.

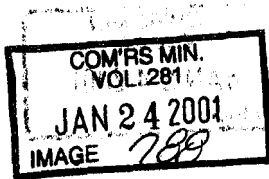

Section 405 Open Sewer

No person constructing a sanitary sewer or sanitary building sewer, shall leave same open, unsealed or incomplete in such fashion as to permit storm or subsurface water to enter such sewers.

Section 406 Excavation/Fill Permit

Any person owning or having possession, charge or management of any lot or parcel of real estate in which there exist public or private wastewater treatment works and on which an excavation/fill is to be made, shall, before making such, apply to the Director for a permit authorizing the same to be made. This application shall consist of submitting drawings to the appropriate agency showing plan and profile of the existing and proposed work to be performed over the existing sewer. These plans shall be sealed and signed by a Registered Engineer or Surveyor.

Prior to any work commencing, the owner/applicant shall engage an approved engineering firm to inspect the existing sewer system and submit to the District a written report with a video tape and/or photographs of the existing conditions of said sewer. In addition, above ground shots showing the area from manhole to manhole will be required. This report shall also include items such as T-Locations, voids, distortions from original shape, cracks in invert, crown, etc., sediment buildup, active or inactive slide conditions and the station or distance from existing manholes concerning each item or other pertinent information. This report shall be signed and sealed by a registered engineer and will be reviewed by the District to determine if replacement or rehabilitation of the sewer system is necessary.

The owner/applicant shall also submit a letter of intent from the engineering firm stating that they will submit to the District a final report, including the items listed above, no sooner than one year after the work has been completed.

Prior to any inspection work commencing, said engineering firm shall be required to sign a waiver of liability holding the District (City of Cincinnati/Hamilton County Board of Commissioners) harmless from all claims, action, damages or injuries to persons, etc., which may occur while inspecting the existing and/or new sewers.

If the Director is satisfied that the proposed excavation/fill will not obstruct, damage or interfere with any lawfully existing public or private wastewater treatment works, under his management, he shall issue a permit authorizing the fill.

In the event it becomes necessary to adjust, relocate or otherwise modify any existing public or private wastewater treatment works as a result of the excavation/fill, the applicant authorized to make the excavation/fill shall, at his expense, make such adjustments, relocations or modifications, as required by the Director, before or during the excavating/filling operation. The applicant shall post a bond, in an amount to be determined by the Director, covering the replacement cost of the existing or modified public or private wastewater treatment works and guaranteeing that the aforementioned excavation/fill will not damage the public or private wastewater treatment works either existing or modified. The bond shall be in force for a period of one (1) year after the work is completed. It will be the owner's/applicant's responsibility to contact the District when all work has been completed to commence the one year waiting

period prior to the final inspection taking place.

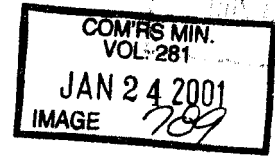

Section 407 Tampering; Damaging

No unauthorized person shall maliciously, willfully, or negligently break, damage, destroy, deface, cover, or tamper with any wastewater treatment works which is a part of the wastewater treatment system under the Director's management. Any person violating this provision shall be subject to immediate arrest under charge of disorderly conduct.

Section 409 Retention of Records

All Users subject to these Rules and Regulations shall retain and preserve for no less than three (3) years, any records, books, documents, memoranda, reports, correspondence and any and all summaries thereof, relating to monitoring, sampling and chemical analyses made by or in behalf of a User in connection with its discharge. All records that pertain to matters which are the subject of enforcement or litigation activities brought by the District shall be retained and preserved by the User until all enforcement activities have concluded and all periods of limitation with respect to any and all appeals have expired. Any or all of the aforementioned shall be made available to the District, OEPA and USEPA for inspection and photocopying at reasonable times and places.

ARTICLE VI

DESIGN OF SANITARY SEWERS

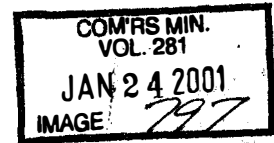

Section 601 Determination of the Amount of Sewage for Sanitary Sewers

A. MSD Design Standards for estimating sanitary sewage flow from new developments

1. Residential Sanitary Sewage

The average flow of sanitary sewage shall be computed on the basis of 100 gallons per capita. The peak flow for various situations shall be in accordance with the following table:

<u>POPULATION</u>	<u>PEAK FLOW</u>
Under 750	4 times the average
Under 1,000	3.9 times the average
Under 1,750	3.8 times the average
Under 2,500	3.6 times the average
Under 5,000	3.3 times the average
Over 5,000	Consult the Director

2. Industrial and/or Commercial Sewage

The amount of sewage shall be fixed after consultation with the Director.

3. Infiltration/Inflow

An allowance of 1000 gallons per acre per day for the gross tributary area of the drainage basin shall be added to the above peak sanitary flows.

B. Determination of the Amount of Sanitary Sewage for Existing Sanitary Sewer Upgrades

1. The design capacity of sanitary sewers and pump stations shall be based on the result of current flow monitoring and modeling in accordance with MSD Guidelines for Sanitary Sewage Flow Estimation (listed below). If these results produce a design flow rate less than that determined under Section 601 (A.), then the amount determined using the method in Section 601 (A.) shall be used.

MSD Guidelines for Sanitary Sewage Flow Estimation:

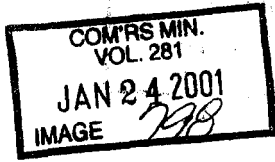

- a. The design flow will be based on the model-projected peak sewer flow rate from a design storm with an applicable recurrence interval. The design flow will be comprised of three components:
 - i. Base wastewater flow (BWF);
 - ii. Groundwater infiltration (GWI);
 - iii. Rainfall-derived inflow/infiltration (RDII).

- b. The design flow components will be determined using the following criteria:
 - i. BWF will be established using either
 - (1) MSD guidelines for peak diurnal flow (per Section 601A. and B.), or
 - (2) Peak diurnal flow observed during flow monitoring, whichever is greater.

 - ii. GWI will be set at the maximum rate observed during a one-year flow monitoring period, or that projected to be the typical annual peak GWI rate (i.e. peak rate expected once per year) if flow monitoring results are considered to be not representative of typical conditions.

 - iii. RDII will be established using the following conditions:
 - (1) The Soil Conservation Service (SCS) Type II rainfall distribution;
 - (2) Antecedent soil moisture conditions that correspond to the maximum observed wet-weather flow during a one-year flow monitoring period shall be assumed in estimating the design RDII flow rate. If flow monitoring results are not considered to be representative of typical conditions for this purpose, then the flow monitoring data shall be used to project to the maximum antecedent soil moisture conditions expected to occur once per year, which will be used for establishing the design RDII flow rate.

2. Flow from any undeveloped portions of the service area of the upgrade sewer/pumping facility will be accounted for using the full build out conditions for those areas and the MSD Design Standards for estimating sanitary sewage flow from new developments (per Section 601 (A.)).

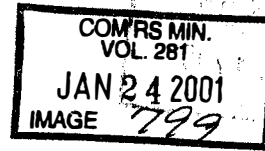

C. Special Conditions

Where special conditions are identified, determination of the amount of sewage shall be fixed after consultation with the Director.

Section 602 Determination of Conduit Size

The minimum conduit diameter for sewer purposes (except building sewers) shall be eight (8) inches. For sewers up to and including twenty-four (24) inches in diameter, design for the above volumes of sewage with the sewer flowing half full. For sewers twenty-seven (27) inches in diameter, design for the above volumes of sewage with the sewer flowing at 0.6 depth and for sewers thirty (30) inches in diameter and larger, design for the above volumes of sewage with the sewer flowing at 0.7 depth.

Use Manning's Formula with an "n" factor of 0.013 in design.

Section 603 Determination of Minimum Allowable Conduit Slope (Manning's Formula)

The Minimum Allowable Slope shall be that which results in a velocity of two (2) feet per second when the conduit flows at 1/4 of full depth.

SIZE	SLOPE (PERCENT)
8" Conduit	0.70
12" Conduit	0.40
15" Conduit	0.30
18" Conduit	0.24
21" Conduit	0.19
24" Conduit	0.16
27" Conduit	0.14
30" Conduit	0.12

Section 604 Placement of Manholes

Manholes shall be placed at intersections of two or more sewers; at changes of size of pipe, alignment, or grade; at the head end of the sewer; at curves on sewers 30" in diameter and larger (preferably on the upstream side of the curve); and at intermediate intervals as follows:

8" to 18"	400 ft. maximum
21" to 27"	500 ft. maximum
30" to 42"	600 ft. maximum

Manholes on pipes 24" and larger shall have flat slab tops in accordance with Standard Drawing Accession Number 49049.

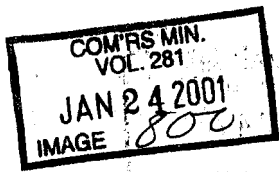

Section 605 Location of the Sanitary Sewer

The sanitary sewer shall normally be within the confines of the street right-of-way or the utility easement adjacent to the street right-of-way or a combination of both where there is a conflict with other utilities:

A. Within the street right-of-way:

The location of the sanitary sewer shall be within the confines of the street pavement with manholes located five (5) feet off the centerline of the street. This will allow the other utilities to be located in their traditional location as follows:

1. Storm sewers should be within the confines of the street pavement with manholes located five (5) feet off the centerline of the proposed street.
2. Gas mains should be between the curb line and right-of-way line on the south or west side of the proposed street.
3. Water mains should be between the curb line and the right-of-way line on the north or east side of the proposed street.
4. -- Electric and Telephone Conduits will be within easements adjacent to the street right-of-way.

B. Within the utility easement adjacent to the street right-of-way as per the Hamilton County Engineer's Subdivision Standard Drawing #2A:

The location of the sanitary sewer shall be within the confines of the utility easement (minimum ten feet in width), the centerline of sanitary sewer shall be a minimum of ten (10) feet from the centerline of the storm sewer and maximum of 13.5 feet from the curb-line of the pavement. No other utilities except storm sewer shall be installed in this side of the street right-of-way and utility easement where sanitary sewers are installed.

If the above locations are not to be used, the special approval of location shall be obtained from the Director.

Section 606 Drop Connections into Manhole

When branch sewer connections are made to a manhole, the branch line must be connected in such a manner that its crown elevation at the centerline of the manhole matches that of the outlet pipe. The manhole bench shall be channeled in such a manner as to direct the incoming flow to the outlet pipe.

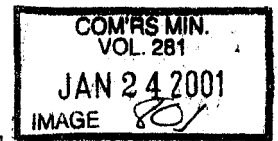

Drop connections into manholes in accordance with Standard Drawing Acc. No. 49003 shall only be used where approved by the District. For new sewer systems, drop connections shall be avoided when the difference in elevation between the outgoing and incoming pipes is less than four (4) feet by increasing the slope of the incoming sewer such that the crown elevation equals the crown elevation of the outgoing pipe. For sewer replacements, existing sidelines may continue to enter the replacement sewer at their present elevation. However, if the invert of the main sewer is two (2) feet or more below the invert of the incoming branch sewer, the branch sewer connection shall be made with a drop connection.

For special conditions, the Director will review written requests for approval of a variance to this section on a case-by-case basis. Examples of such special conditions include:

- A. Unavoidable utility conflicts;
- B. Severe ground conditions;
- C. Inside drop connections for existing manholes;
- D. Unforeseen construction conditions.

Section 607 Joints for Sanitary Sewers

All sanitary sewers, including sanitary building sewers and manholes, shall be built with resilient and flexible compression joints, or an approved equal, as determined by the Director, in accordance with the District's Specifications and Standards.

Section 608 Suitable Ground for Sewer Construction

Sewers and appurtenances shall be constructed in original ground, wherever possible. However, when they must be constructed in fill, said fill shall be controlled, compacted and inspected by an approved testing laboratory or an inspector from the appropriate public authority. Minimum compaction requirements, subject to rules or specifications of the public authority, shall be those spelled out in the latest edition of the "STATE OF OHIO, DEPARTMENT OF TRANSPORTATION, CONSTRUCTION AND MATERIALS SPECIFICATIONS," for Embankment Soil Compaction Requirements.

Section 609 Steep Sewer Sections

- A. Conduit Sizes 8" through 24"

For sewer slopes twenty percent (20%) or greater, pipe shall be PVC-SDR35 or material approved by MSD and be anchored with concrete keyblocks as shown on Standard Drawing Accession No. 49039 spaced as follows at joints only. For slopes between 20 percent and 35 percent, keyblocks shall be installed at intervals not more than 36 feet center to center. For slopes 35 percent to 50 percent, keyblocks shall be installed at intervals not more than 24 feet center to center. For slopes over 50 percent, keyblocks shall be installed at every joint of the installed pipe. Such steep sewer sections shall be terminated at the bottom of the steep slope with a special

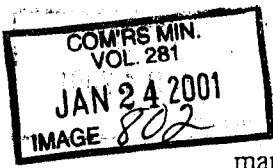

manhole designed and constructed to dissipate the thrust and downward force of the sewer system at the manhole.

B. Conduit Sizes 27" and Larger

For sewer slopes fifteen percent (15%) or greater, pipe shall be ductile cast iron or material approved by MSD. For sewer slopes between fifteen percent (15%) and twenty-five percent (25%), keyblocks shall be provided at every joint. Keyblocks shall be installed as shown on Standard Drawing Accession No. 49039. Such steep sewer sections shall be terminated at the bottom of the steep slope with a special manhole designed and constructed to dissipate the thrust and downward force of the sewer system at the manhole.

Section 610 Concrete Cradles

When it is considered advisable in the judgment of the Director, the sewer pipe shall be laid in a concrete cradle, Type "A" or Type "B," as shown on Standard Drawing Accession No. 49044.

Section 611 Sewer Pipe in Creek Beds and Shallow Installations

Sewer pipe in creek beds and in shallow installations shall be encased in concrete when the cover is less than four feet (4') or when it is considered advisable in the judgment of the Director. Type "B" encasement as shown on Standard Drawing Accession No. 49044 shall be used. When the cover on such pipe is two feet (2') or less, the pipe, from manhole to manhole, shall be Ductile Cast Iron, or an approved equal as determined by the Director, encased as noted above.

Special mitigative measures shall apply for all sewer crossings and sewer construction in creek riparian areas:

- A. Sewers crossing streams shall be designed to cross the stream as nearly perpendicular to the stream as possible.
- B. Sewer systems shall be designed to minimize the number of stream crossings, and to be located as far from streams and riparian areas as possible.
- C. Sewer construction easement widths should be minimized.
- D. Unnecessary damage to trees for sewer construction shall be avoided.
- E. Controls to minimize both erosion and sedimentation shall be implemented.

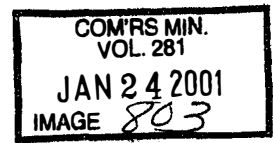

Section 612 Sewer Construction within Special Flood Hazard Areas

No public or private sewer, or system of sewers, shall be constructed or located within any Special Flood Hazard Area unless the Director certifies that the sewer or system of sewers is proposed to be located and constructed in such a manner as to minimize or eliminate flood damage to them and:

- A. Minimize or eliminate the flow or infiltration of flood waters into or out of such systems during and after the base flood discharge, OR
- B. Have all parts elevated at least one (1) foot above the base flood level.

Section 613 Low Pressure Sewer Systems

When the construction of a gravity sewer system is not reasonably possible as determined by the Director, an alternative low-pressure sewer system will be considered for approval. Where approved, the design and construction shall be in accordance with the District's latest specifications, standards, policies and procedures.

Section 614 Backwater Preventer

The District requires that a sewage backwater valve be installed in accordance with the requirements of any local jurisdiction's plumbing code for plumbing fixtures where the elevation of the overflow rim of the lowest plumbing fixture is below the elevation of the rim of the next upstream manhole in the sewer system that the building is connected to.



ARTICLE X

CONSTRUCTION PROCEDURE

Section 1001 General Construction Specifications

Sewers shall be constructed in accordance with the requirements of the latest editions of the "State of Ohio, Department of Transportation, Construction and Materials Specifications" and the "City of Cincinnati, Supplement to the State of Ohio, Department of Transportation, Construction and Materials Specifications."

Section 1002 Typical Trench for Sewer Pipe

The trenches in which sewer pipe is laid shall conform to the "control dimensions" for Typical Trenches for Conduits, Standard Drawing Accession No. 49032, and the sewer pipe shall be bedded as indicated on that drawing. The trenches shall be backfilled in accordance with the requirements of 603 of the State of Ohio, Department of Transportation, Construction, and Material Specifications.

Excavation around manholes in streets that are paved or are to be paved shall be backfilled in accordance with the requirements of the appropriate public authority. Restoration of existing pavement is to be made in accordance with the requirements of the appropriate public authority.

Section 1003 Leakage Tests

All conduits shall be subjected to a leakage check either by an infiltration or exfiltration test with water or by an air test.

- A. The infiltration test allowance, on conduits twenty-seven (27) inches and larger, shall be 0.079 gallon per inch of the internal diameter per 100 feet of conduit per hour. The exfiltration test allowance shall be the same as for infiltration except that an additional allowance of ten (10) percent over the basic allowance shall be allowed for each two (2) feet of head over a basic two foot minimum head.

This test, including furnishing of all appurtenances therefor, shall be performed at the Contractor's expense.

The above infiltration test requirements will continue to be allowed for conduits twenty-seven (27) inches and larger during the first six months these Rules and Regulations are in force, starting with the effective date. After six months from the effective date, infiltration tests will only be allowed for conduits larger than thirty-six (36) inches. All other conduits must be tested by the air test method as required under Item B of this Section.

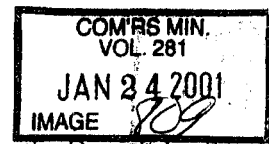

- B. Air tests on the following sizes of sewers will continue to be performed by the District for the six months after the effective date of these Rules and Regulations. After six months from the effective date, the District will no longer perform air tests, and all air test requirements under Item B of this Section will become obsolete.

The air test, for conduits twenty-four (24) inches and under, consists of inserting plugs in the line, thus isolating test sections between manholes. Air is then admitted to the isolated test section until it is under pressure of 3.5 pounds per square inch. All valves leading to or from the test section are then closed and the air supply line disconnected. The time elapsing before the pressure in the test section drops to 2.5 pounds per square inch is noted and recorded.

The test section shall be considered as having passed the air test if the elapsed time as noted above is equal to or greater than the following times:

- For 8" Conduit 4 Minutes
- For 12" Conduit 5-1/2 Minutes
- For 15" Conduit 7-1/2 Minutes
- For 18" Conduit 8-1/2 Minutes
- For 21" Conduit 10 Minutes
- For 24" Conduit 11-1/2 Minutes

- C. All air tests starting in six months from the effective date of these Rules and Regulations shall be performed in accordance with the latest applicable ASTM or UNI-BELL PVC Pipe Association requirements for each unique pipe material for leakage test requirements and shall be performed at the contractor's expense. An air pressure adjustment shall be made if the groundwater is above the top of the pipe as outlined in the applicable ASTM or UNI-BELL PVC Pipe air test method.

Section 1003-A Deflection Test

Deflection tests shall be performed on all flexible conduits as described in the latest edition of the City of Cincinnati Supplement to the State of Ohio Construction and Materials Specifications.

Section 1003-B Vacuum Testing

The Contractor shall test all manholes leakage by means of vacuum testing. The vacuum testing cannot be done until after the manholes are set to final grade and the manhole castings are bolted down. All lift holes shall be plugged. Any other openings, such as for pressure relief valves, shall be temporarily plugged to allow the vacuum test. All pipes entering the manhole shall be plugged and care shall be taken to securely brace the plugs from being drawn into the manhole. The vacuum equipment test head shall be placed in the opening of the top slab or cone section and the seal inflated in accordance with the manufacturer's recommendations. Vacuum testing shall be in accordance with ASTM C1244. A vacuum of 10 inches mercury (10" Hg) shall be drawn and the vacuum pump shut off. With the valves closed, the time shall be measured for the vacuum to drop to nine inches mercury (9" Hg). The manhole shall

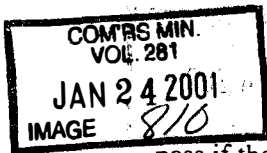

pass if the time meets or exceeds the allowable times as calculated from ASTM C1244, or as approved by the Engineer.

Section 1004 Temporary Manhole Covers

In the construction of subdivisions or housing developments, the Contractor shall place a temporary manhole cover, Standard Drawing Accession No. 49045, on all sanitary manholes. This temporary cover is to remain in place from the time the manhole is constructed until a permanent casting, Standard Drawing Accession No. 49005, No. 49050, or No. 49051 is placed on the sanitary manhole.

Section 1005 Plug Subdivision Sewer at Point of Connection

Sanitary sewers in subdivisions under construction shall be sealed where they connect to the existing sewers. This work shall be done only in the presence of a District Inspector.

After construction has been completed and the sewers in the subdivision have been inspected, tested and found to be substantially completed and operational by the District, the seal(s) shall be removed by the developer. Again, this work may be performed only in the presence of a District Inspector.

Section 1006 Sewer Tap Permits for Substantially Complete and Operational Sewers

No sewer tap permits shall be issued until (1) the sewer or sewers to be tapped and the wastewater treatment plant, and/or lift station, have been inspected, tested and found to be substantially completed and operational by the District; (2) the engineer for the Developer has furnished to the District a mylar copy of the Development Plan showing all information as required in Section 1007 of these Rules and Regulations; and (3) all applicable requirements of the agreement between the Developer and the Board have been met.

Section 1007 "As Built" Plans

- A. After completion of construction of a wastewater treatment works and before acceptance of the wastewater treatment works by the Board, the Developer's engineer shall furnish to the District complete "as built" plans of these wastewater treatment works; drawn on 24" x 36" Mylar and containing the following information:
1. Elevations are to be referenced to U.S. Coast and Geodetic Survey Triangulation Stations and Bench Marks.

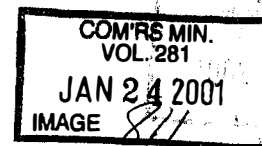

2. A tie-in to the invert of the existing sewer system (except in cases where a temporary wastewater treatment plant or lift station serve to isolate the new sewer system from the existing system). The existing sewer shall be identified by its number.
3. Rim elevation and invert elevation(s) taken at the center of the manhole to the one-hundredth of a foot.
4. Depth of manhole shown shall be the difference between the rim elevation and the mid-point of the trough between influent and effluent inverts.
5. In the case of a drop manhole or a manhole with a pipe entering on a steep grade, elevations should be taken at the center of the manhole, and at a point on the invert that will be most representative of the true grade of the existing pipe. Sketch showing location of elevations and distances should be included with the plans.
6. Distances between manholes to the one-hundredth of a foot taken at the center of the casting.
7. Angles to the nearest minute.
8. Angular ties between existing and new sewers shall be shown on the plans.
9. New distances and angle of a new installed manhole on an existing sewer.
10. Grade of the conduit.
11. Size of the conduit.
12. Pipe material.
13. Lateral locations shall be shown by dimensioning from the downstream manhole at the main sewer and an offset distance to the end of the lateral at the right-of-way or property line.
14. All major changes in location.

This information shall be shown in red ink on the approved plan and profile tracing.

- B. In lieu of the Developer providing the "as built" plans, the Developer may opt to have Metropolitan Sewer District survey personnel provide sanitary sewer "as built" for a fee, as specified in Section 2501. The following procedure will apply:
 1. Once a sewer project passes a final inspection, an "as built" survey will be scheduled and completed within ten working days. All revisions to the improvement plans are to be submitted and approved prior to scheduling.

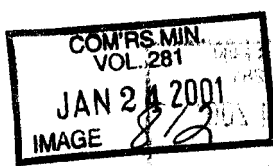

2. If the survey information proves satisfactory, the "as built" can be processed for approval.
 3. MSD engineering personnel will add the "as built" data to the project mylars.
 4. Immediate notification will be sent in instances where the sewer does not meet the District's minimum grade requirements, as defined in the Rules and Regulations. Additional tap permits will be withheld until this issue is resolved. Disputes that may arise will be resolved through a joint meeting at the job site between MSD engineering personnel and the developer's professional surveyor.
- C. An option must be selected at the time detail plans for a sewer project are submitted. Payment for MSD-provided "as built" is required prior to the issuance of tap permits beyond the allowable 10%.

Section 1008 Prefabricated Wastewater Lift Stations and Treatment Plants

Prefabricated Wastewater Lift Stations and/or Treatment Plants shall be placed on and anchored to reinforced concrete slabs.

Metal tanks shall be thoroughly protected against corrosion by special corrosion resistant paints and cathodic protection.

Section 1009 Contractor License

All work done on sanitary and/or combined sewers within the jurisdiction of the District must be done by a contractor who is an approved sewer tapper properly licensed and bonded by the District.

Section 1010 Sewer Grade Variance Policy

- A. **GENERAL.** The Metropolitan Sewer District will review and approve all plans for the extension of the public, and private sewer system, prior to issuing authorization to construct. Public and private sewers shall be constructed in strict accordance with the approved plans, to the extent possible. All variations from approved alignments or grades must be identified and submitted to the Director for review, consideration and approval or disapproval prior to acceptance of the sewer extension as part of the public sewer system.
- B. **MINIMUM SEWER GRADES.** The Metropolitan Sewer District has established in its Rules & Regulations minimum sewer grades for each sewer size and for limited service sewer sections based on the required grades to keep solids flowing (minimum cleaning velocities). Sewers installed at less than these minimum grades increase the risk of sewer stoppages and necessitate more frequent cleaning schedules.

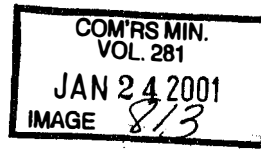

- C. REQUIRED SEWER CAPACITY. The Metropolitan Sewer District requires that the sewers be sized and placed on a grade that will provide adequate carrying capacity to serve the total upstream watershed, at full development and at peak flow conditions.

- D. VARIATIONS FROM APPROVED GRADES. Should a sewer be installed at less than the approved minimum grade or critical grade, as defined above, the Metropolitan Sewer District may require the sewer to be relayed at the required grade or increased in size.

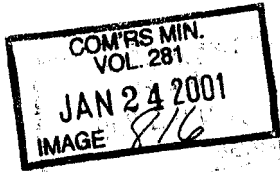

ARTICLE XII

BUILDING SEWERS: CONNECTIONS AND PERMITS

Section 1201 Authorization to Connect

No unauthorized person shall uncover, make any connection with an opening into, use, alter or disturb a public or private sanitary or combined sewer or appurtenance thereof. No person, authorized to do the above type of work, shall do so without first obtaining a permit therefor from the Director.

Section 1201a Unauthorized Discharge/Connection

In accordance with Section 401, no person shall discharge or cause to be discharged, either directly or indirectly, to a sanitary sewer system building connection or appurtenance thereof, surface water, foundation drains, groundwater, roof runoff, subsoil drains, subsurface drainage, cooling water, swimming pool water or unpolluted industrial process water.

The owner whose property is sewered by the building connection shall be responsible for any such unauthorized connection and its immediate removal and shall be subject to penalties in accordance with Section 2207, Article XXII.

Section 1202 Building Sewer

A separate and independent building sewer shall be provided for every building that is to be occupied. The minimum size shall be six (6) inches.

Section 1202-A Building Sewer Extension

Where one building stands in the rear of another on an interior lot and no "building sewer-sanitary" connection to a sewer is available, or can be made through an adjoining alley, courtyard, side yard, or driveway, as determined by the Director, the "building sewer-sanitary" from the building on the front of the lot may be extended to the building on the rear of the lot and will be considered as one "building sewer-sanitary" with a 6" diameter minimum cleanout installed at the property line or right-of-way.

Section 1203 Building Sewer Connection to Manhole

A building sewer, six-inch (6"), connection to a public sanitary or combined sewer manhole is prohibited, except where special approval is granted by the Director.

Section 1204 Building Sewer Requirements

The building sewer, six-inch (6"), shall be constructed of materials meeting the standards of the District. It shall be laid at a minimum grade of one-fourth inch per lineal foot (2%) from the building to the public or private sewer; except that the Director may authorize the grade to be as little as one-eighth inch per lineal foot (1%) if he determines such to be desirable or necessary. The building sewers, larger than

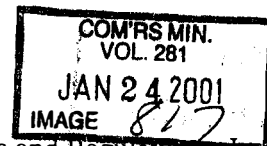

six-inch (6"), shall be installed in accordance with Section 603 of these Rules and Regulations. In no case shall a floor level being served by the building sewer be less than thirty-six inches (36") above the crown of the receiving sewer at the point of connection of the building sewer thereto. It shall be the owner's responsibility to whom the permit is issued to take the necessary precautions in order to provide adequate protection from flooding for any new connection.

Section 1205 Building Sewer Connection

Building sewers shall be constructed as part of the improvement to the property line of the premises served. The connection of the building sewer to the main sewer shall be made in front of the premises served, unless otherwise approved by the Director.

Section 1206 Residential Subdivisions

In the development of residential subdivisions with sanitary sewers, all lots shall be served by connections to the sanitary sewer system either by gravity or by means of a pump or ejector. No individual disposal devices will be permitted.

In all buildings in which any sanitary building drain is too low to permit gravity flow to the sanitary sewer system, any sanitary sewage carried by such building drain shall be lifted by an approved means and discharged to the building sewer.

Section 1207 Maintenance

For maintenance of building sewers, see Section 2008 of these regulations.

Section 1208 Sewer Tapping

Permits to connect building sewers, to open, or alter any public/ private sanitary or combined sewer or appurtenance will be issued only to a person engaged in the business of sewer construction or tapping and possessing a valid license and bond from the District.

Section 1208-A Verification of No Clean Water Connections

Prior to the issuance of a sewer permit allowing for a new connection, opening, or alteration, to a sanitary sewer or appurtenance, on-site verification is necessary to insure that no clean water will enter the sanitary sewer system should a connection or alteration be permitted.

The owner of a property shall be responsible for complying with the District's current policies and procedures relative to protecting the sanitary sewer from clean water sources.

Section 1209 Responsibility of Permit Holder

The person to whom a connection permit is issued will be held responsible for the proper installation of the building sewer in accordance with these Rules and Regulations subject to the condition that the person holds the District harmless from any loss or damage.

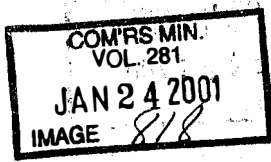

Section 1210 Additional Permits

The person to whom a connection permit is issued shall be responsible for obtaining any additional required permits to open cut any street, road or highway, from the appropriate public authority having jurisdiction over such street, road or highway, and shall comply with all conditions required by such additional permits.

Section 1211 Building Sewer Connection Permits (Tap Permit)

There shall be two types of permits for building sewer connection (tap permit): (1) for residential and commercial service, and (2) for service to establishments discharging industrial wastes. In either case, the owner or his agent shall make application on a special form to be obtained from the District. The application for permit shall be supplemented by a copy of the Building Permit, documentation stating the domestic water meter size, detailed site plan showing elevations at the sewer main and the lowest floor elevation of the building, applicable street opening permits, a schematic plan of the footing and foundation drainage system showing the point of discharge and any plans, specifications or other information considered pertinent in the judgment of the Director. A separate tap permit must be obtained for each building sewer connection. A tap-in-fee in accordance with Section 1215 for each tap permit requested shall be paid to the District at the time the application is filed. This fee is specified in Sections 1215 and 2501 of these Rules and Regulations.

Section 1212 Licenses and Bonds

Sewer tappers performing building sewer connections to the District's sewer system shall be licensed by the District. The annual license fee is specified in Section 2501. The license shall be in effect from January 1 to December 31 of each year. Failure to renew this license within a two-year period, after the expiration date, shall result in a new examination being required.

Each license application shall be accompanied by a sewer tapper's bond in the amount of ten thousand dollars (\$10,000.00).

All licensed and bonded sewer tappers are responsible for controlling erosion and sediment.

The District reserves the right to revoke or suspend the license of any holder whose work, or misconduct as a sewer tapper is not in the District's and/or public's best interest. The Director will investigate and review the instance(s), notify the license holder of the time and place for a hearing at which the licensee shall have the right to appear and produce evidence and witnesses for his/her own defense, and make a final decision as to the revocation or suspension of a license.

Section 1213 Inspection of Building Sewers

Inspection of building sewer connections will be provided by appointment, arranged through the Field Section, during normal working hours that are 7:30 a.m. to 4:00 p.m., Monday through Friday. Special Services will be provided when requested. Typical Special Services are (1) return trips due to lack of

expected progress; (2) emergency conditions necessitating immediate response; and (3) abnormal working hours. The permit holder will be billed for Special Services of inspection time at a rate per hour, established and published from time to time by the Board.

Section 1214 Method of Connecting Building Sewers

Building sewers shall be connected to 33-inch or smaller diameter sanitary or combined sewers by one of the following methods:

1. By utilizing an existing T or Y branch.
2. By the use of an approved tapping saddle.
3. By removing a full pipe-length of the existing sewer and "rolling-in" a new length of pipe with a T or Y branch made an integral part thereof.
4. By the use of other methods as may be approved by the Director.

If a new length of pipe is "rolled-in," a concrete collar in accordance with Standard Acc. No. 49031 shall be constructed or an approved coupling installed at each end where the new pipe meets the existing pipe.

Building sewers shall be connected to 36-inch or larger diameter sanitary or combined sewers in a manner as approved by the Director.

"Break-in" connections shall not be permitted unless approved by the Director.

Section 1215 Tap-in-Fee

The tap-in-fee shall apply to direct or indirect connections to public or private sanitary and combined sewer systems within the jurisdiction of the District.

- A. Every person (meaning individuals, firms, corporations and public bodies) whose premises will be served by a sanitary or combined sewer of the Metropolitan Sewer District shall pay a Tap-in Fee in accordance with Table 1215-1 and subject to the provisions of Section 1215 B of these Rules and Regulations. The Tap-in Fee shall be paid when a sewer tap permit is issued by the Metropolitan Sewer District or when the responsibility of the applicant to supply to MSD a record of the relevant water service in order to verify the size of the water meter at the time of the tap-in is required.

Table 1215-1		Tap-in Fee
Water Meter Size	up to 3/4"	\$2,500.00
	1"	\$4,530.00

Section 1215 Amendments April 2, 2014

Other Amendments to this Section were adopted

- August 28, 2002
- September 7, 2005

These were repealed with the 2014 Amendment

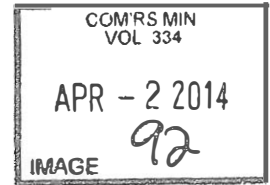

ARTICLE XII

BUILDING SEWERS: CONNECTIONS AND PERMITS

Section 1215 Tap-in-Fee

The tap-in-fee shall apply to all new direct or indirect connections to both public or private sanitary and combined sewer systems under the jurisdiction of the District.

- A. Every person (meaning natural persons, firms, associations, corporations and public bodies) whose premises will be served by a direct or indirect connection to a sanitary or combined sewer of the Metropolitan Sewer District of Greater Cincinnati shall be charged a Tap-in Fee in accordance with Table 1215-1 and subject to the applicable provisions in Section 1215 B of these Rules and Regulations. The Tap-in Fee is due and payable when a sewer tap permit is issued by the Metropolitan Sewer District or its designee. It will be the responsibility of the applicant to supply to MSD a record of the relevant water works application of water service in order to verify the size of the water meter at the time the permit application is submitted.

Table 1215-1

Water Meter Size	2014 Tap-in Fee
up to ¾"	\$3,620.00
1"	\$6,560.00
1-½"	\$15,010.00
2"	\$27,020.00
3"	\$61,280.00
4"	\$109,430.00
6"	\$247,530.00
8"	\$440,740.00
10"	\$688,280.00
12"	\$990,130.00

- 1. The tap-in-fee will be adjusted annually as follows, in accordance with Section 2501:
 - a. Based on the September Engineering News Record Construction Cost Index (ENR CCI) for Cincinnati, Ohio, the fees in Table 1215-1 shall be multiplied by the ratio of the current year September ENR CCI to the ENR CCI for September, 2000 (5907.06), rounded to the nearest \$10.



- b. The Tap-in fees determined in a., above, shall become effective on January 1 of each year.

B. Conditions, exceptions, and additional information:

1. For single-family residences existing as of July 1, 1996, the Tap-in Fee shall be \$480. For purposes of this section, a single-family residence shall be considered to be "existing" if a final plumbing inspection was completed and approval granted by the appropriate local authority on or before July 1, 1996. It shall be the responsibility of the applicant to furnish a record of the final plumbing inspection in order to verify the date of final plumbing approval.
2. For single-family residences constructed after July 1, 1996 that are converting from private to publicly-owned, operated, and maintained sanitary sewers, the Tap-in Fee for up to ¾" water meter branch size shall be \$480, in accordance with Table 1215-3
3. For residential condominium properties, in accordance with Chapter 5311 of the Ohio Revised Code, the Tap-in Fee shall be calculated based upon number of units, and the Tap-in Fee shall be \$480 per unit.
4. In areas where a connection charge or local benefit charge greater than the applicable Tap-in Fee set forth in Table 1215-1 was established by a prior resolution of this Board or by another political subdivision which has since joined the Metropolitan Sewer District, only the applicable Tap-in Fee set forth in the prior resolution shall be collected.
5. In areas where a connection charge or local benefit charge less than the applicable Tap-in Fee set forth in Table 1215-1 was established by a prior resolution of this Board or by another political subdivision which has since joined the Metropolitan Sewer District, only the applicable Tap-in Fee set forth in Table 1215-1 shall be collected.
6. Properties located outside of Hamilton County and served by the sewer facilities of the Metropolitan Sewer District are subject to the Tap-in Fees in this Section. The agency issuing that tap permit shall collect the appropriate Fee and shall forward this Fee to the Metropolitan Sewer District.
7. When a premises is supplied either in whole or in part with water from wells or any other source other than a public water supply, MSD will contact the local water district to determine the comparable water meter size which would be needed to serve the premises. In the event there is no local water district, the Director of the Metropolitan Sewer District will determine comparable water meter size.
8. Where a combination service line and water meter for both domestic and fire service is provided MSD will contact the local water district to determine the domestic water demand and appropriate water meter size for that demand in



order to determine the Tap-in Fee. The Director of the Metropolitan Sewer District shall have the authority to determine the proper Tap-in Fee.

9. When a person can show to the satisfaction of the Director of the Metropolitan Sewer District that a portion of the water used on the premises will not enter the sewer system, The Director of the Metropolitan Sewer District shall have the authority to reduce the Tap-in Fee.
10. An owner of a single family residence with a water meter larger than 3/4-inch may pay a Tap-in Fee equal to the rate set for buildings with up to a 3/4" water meter, provided the owner furnishes an affidavit stating the reason for the increased size of the water meter and a statement confirming that no non-residential activities will occur at the premises which will allow additional water to enter the sewer system.
11. Applicants for sewer tap permits under the following circumstances will be charged Tap-in Fees as follows:
 - a. No additional tap-in fee will be charged for an existing building with a permitted sewer tap which is demolished or destroyed, is replaced with a new building on the same site, and for which the water meter size for the replacement building is the same as the water meter size for the demolished or destroyed building. Where records do not exist on water meter size, the minimum water meter size, as indicated in Table 1215-2, will be assumed.
 - b. For an existing building with a permitted sewer tap which is demolished or destroyed, is replaced with a new building on the same site, and for which the water meter size for the replacement building is increased from the water meter size for the demolished or destroyed building, or in the case where water meter size records do not exist and the minimum size meter is assumed, the Tap-in Fee will be calculated based on the current rates for Tap-in Fees, less the Tap-in Fee previously paid. If no record of prior Tap-in fee payment exists, the Tap-in Fee amount previously paid will be assumed to be in accordance with Table 1215 -2, below, as applicable. Plumbers who fail to pay this fee are subject to being removed from the MSD approved sewer tapper list and have their sewer tapper license revoked.
 - c. For an existing building with a permitted sewer tap for which the water meter is replaced with a new, larger water meter, the Tap-in Fee will be calculated based on the current rates for Tap-in Fees, less the Tap-in fee previously paid. If no record of prior Tap-in fee payment exists, the Tap-in Fee amount previously paid will be assumed to be in accordance with Table 1215 -2, below, as applicable. Plumbers who fail to pay this fee are subject to being removed from the MSD approved sewer tapper list and have their sewer tapper license revoked.

Table 1215-2. For single-family residences:

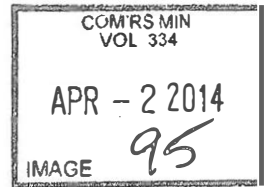

Water Meter Size	Tap-in Fee
up to ¾"	\$480.00
1"	\$870.00
1-½"	\$1,990.00
2"	\$3,580.00
3"	\$8,120.00
4"	\$14,500.00
6"	\$32,800.00
8"	\$58,400.00

Table 1215-3. For buildings constructed on or after July 2, 1996:
(eff. 1/1/2014)

Water Meter Size	Tap-in Fee
up to ¾"	\$480 for properties in accordance with Section 1215(B)(2)
	\$3,620.00 for properties in accordance with Section 1215(A)
1"	\$6,560.00
1-½"	\$15,010.00
2"	\$27,020.00
3"	\$61,280.00
4"	\$109,430.00
6"	\$247,530.00
8"	\$440,740.00
10"	\$688,280.00
12"	\$990,130.00

12. Policy Concerning Tap-in-Fees associated with Residential and Non-Residential Redevelopment.

It is the policy of the Board of County Commissioners to encourage redevelopment throughout Hamilton County. Redevelopment is defined as the removal of one or more buildings of any type from one or more parcels of any zoning, and the replacement of that structure or structures with any number of new structures.

MSD will calculate the tap-in-fees for the new structure(s) within residential or

non-residential redevelopments based on the current rates for tap-in-fees (Table 1215-1 et. seq.), less the tap-in-fee amount for the old structure. The tap-in-fee equivalent for the redevelopment will be the sum of the various size meters times the rate for that meter minus the sum of the pre-redevelopment meter sizes times the present rate for that size meter.

Rates to be used are the rates in effect at the time the development plans are approved for construction.

The redevelopment tap-in-fees balance shall be collected based on building meter size prior to the credit balance being issued. In the event the predevelopment amount is greater than the redevelopment amount, there will be no refund of the difference.

Only those taps within the specific recorded land parcel limits of the original development, whose bounds have been defined by a development plans that has been reviewed and approved by a County or Municipal Zoning or Planning Board or Commission sanctioned by the Ohio Revised Code and Ohio Administrative Code, are transferable.

Each redevelopment that occurs will be based on the most recent previous development. No credits will be given for past redevelopment activity.

To receive the credit for pre-existing taps, the developer must submit satisfactory proof to establish the number and size of pre-existing water meters available for the new development units during the concept or detail plan review process defined under Section V of the MSD Rules and Regulations. The following shall be used to determine "satisfactory proof":

1. Clear written description describing the source of the pre-existing information.
2. A plan clearly showing the location of the pre-existing buildings and water meters in relation to the current parcels lines for which credit is requested.

Approval shall be void if construction has not commenced within twelve (12) months and completed within thirty-six (36) months from the date of the approval of construction letter consistent with Section 510 of these Rules and Regulations. The Director may extend approval for a period not be exceed twelve months.

Credit for pre-existing taps approved during Concept of Detail Plan Review will be granted after Tap Permits have been applied for and granted. No credits for the planned demolition of structure(s) will be granted until the demolition of such structure(s) is complete.

Section 1216 Amendments

AMENDMENT: MSD RULES & REGULATIONS

Section 1216

Policy for Levying Sewer Assessments for Local Collector Sewers - Assessment Credit

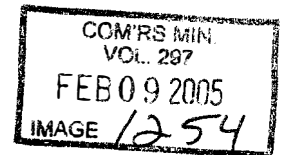

- A. **Single Family or “Primary” Assessment Credit.** It is the policy of the Board to encourage public sewers and to finance sewer improvements, which provide local sewer service, by levying special assessments on the properties receiving benefit from the sewer improvement as provided in Ohio Revised Code Chapter 6117. For single family residences existing as of September 20, 1995, MSD will pay, in the form of a single-family or primary assessment credit, the special assessment for a local sewer, up to \$5,000, provided that:
- 1.) The local sewer eliminates the need for on-site sewage disposal systems and connects to the public sewer system of the Metropolitan Sewer District; or
 - 2.) The local sewer is a replacement or repair of a privately owned local sewer which connects to the public sewer system of the Metropolitan Sewer District, and the private sewer meets MSD standards and is dedicated by its owners to public use in accordance with *MSD Rules and Regulations*.
- B. **“Secondary” Assessment Credit.** It is the policy of the Board to encourage public sewers and to finance sewer improvements, which provide local sewer service, by levying special assessments on the properties receiving benefit from the sewer improvement, as provided in Ohio Revised Code Chapter 6117. For all properties so specially assessed, it is the policy of this Board that MSD will pay, in the form of a secondary assessment credit, all public improvement project costs exceeding \$12,000. **It is the policy of the Board that total actual per-benefit costs of the local public sewer improvement which remains in excess of \$12,000 per benefited property, once the single-family assessment credit has been applied, shall be funded from Metropolitan Sewer District unappropriated funds as a secondary credit.** This secondary credit is applicable to all property types as defined by the Hamilton County Auditor and subject to special assessment under the Revised Code.
- C. **Annual Credit Adjustment.** The single-family assessment credit of Section 1216 (A) will be adjusted annually in accordance with Article 25, as follows:
- 1.) Based on the September Engineering News Record Construction Cost Index (ENR CCI) for Cincinnati, Ohio, the \$5,000 credit shall be multiplied by the ratio of the current year September ENR CCI to the ENR CCI for September 2000 (5907.06), rounded to the nearest \$100.
 - 2.) The Assessment Credit determined in Section 1216 (A) shall become effective on January 1 of each year.
 - 3.) The Assessment Credit in effect at the time of adoption of the Resolution Confirming Revised Assessment shall be applied. For each single family residence, existing as of the September 20, 1995, served by a local collector sewer whose construction costs are assessed under this policy, a sewer tap-in-fee in the amount of \$480.00 will be charged by the Metropolitan Sewer District at the time of connection of the property to the public sewer.

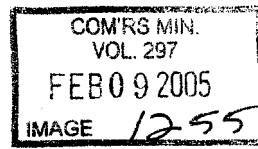

2/2/2005
Exhibit A

MSD IMPLEMENTATION – 1216. Per Chapter 6117 ORC, MSD will report to the Board all costs of a local public sewer improvement project. Also per Chapter 6117, the Board must assess the actual costs of a local public sewer improvement project. However, statute permits the Board to fund a portion of these actual costs from “other available funds” (§6117.06(E)). It is Board policy that the cost of special assessments for local public sewer improvements shall not exceed \$12,000 per benefited property. To this end, MSD will apply the single-family or “primary” assessment credit to the actual per-benefit cost in order to determine if the amount exceeds, is at or below \$12,000. If the amount is at or below \$12,000, this is the amount applied as a final assessment when the Board confirms special assessments (see Section 1805 (D), above). If the amount still exceeds \$12,000, MSD will apply a “secondary” assessment credit to bring the per-benefit amount to be equal to \$12,000. Sections 1805 (E) and 2502 are applicable as well in this implementation.

Costs associated with “private-side” improvements, i.e., connection to the public sewer and abandonment of the existing on-site household wastewater disposal system, are *not* a part of the local public sewer improvement costs.



Section 1216 Policy for Levying Sewer Assessments for Local Public Sewer Assessment Project - Assessment Credit

D. Home Septic Treatment System Reimbursement Credit. It shall be a policy of the Board if a benefited single-family property is currently served by a Home Sewage Treatment System (HSTS), it will qualify for an HSTS reimbursement credit based upon the conditions stipulated in this rule and regulation. This policy is designed to reimburse property owners who have made purchases of HSTS systems deemed to have the capability of effectively treating household wastewater discharges where those systems have been effectively maintained to ensure proper operation and compliance. Nothing in this policy is meant to imply that HSTS are technically or environmentally equivalent to public sanitary sewer systems as it relates to the treatment of household sewage.

Compliant HSTS systems include:

- 1.) Discharging systems, with NPDES permit(s) in effect at the time the credit is approved, and,
- 2.) On-site absorption systems, whereby wastewater is treated on-site and is not discharged to an adjacent property, waterway, or aquifer. Compliant HSTS systems do not include any on-site absorption system operating over an aquifer (otherwise termed by Hamilton County Public Health as a “dry well”).

The HSTS reimbursement credit will apply only to those HSTS systems which:

- 1) As indicated by Hamilton County Public Health, were installed in accordance with the provisions of Hamilton County Public Health regulations enacted on December 10, 2004; and
- 2) As indicated by Hamilton County Public Health, are in compliance with applicable laws and regulations governing the operation of HSTS systems at the time of the order to connect to the sewer system; and
- 3) Possess a discharging system NPDES permit(s) in effect at the time the credit is approved; or
 - a. (Non-NPDES Discharging systems are not eligible for reimbursement under this program.)
- 4) Possess a compliant absorption system.

The County, through MSD, will provide eligible property owners with an HSTS reimbursement credit at the following levels for abandoning their eligible system:

Type of HSTS System	Eligible Reimbursement Amount*
Absorption	\$5,800
Discharge (NPDES Compliant)	\$3,600

*Eligible HSTS reimbursement credit is calculated using the five year annual average cost of local systems as compiled by Hamilton County Public Health, and multiplied by a factor of .20.

Eligible HSTS reimbursement credit amounts, detailed above, will be applied on a parcel-



by-parcel basis to eligible benefited properties required to tap into the public sewer system due to the proximity of a local sewer. The net impact for eligible benefited properties will be to increase the applicable assessment credit by reducing the \$12,000 cost cap, as currently set by Board policy, commensurate with the eligible HSTS reimbursement credit amount.

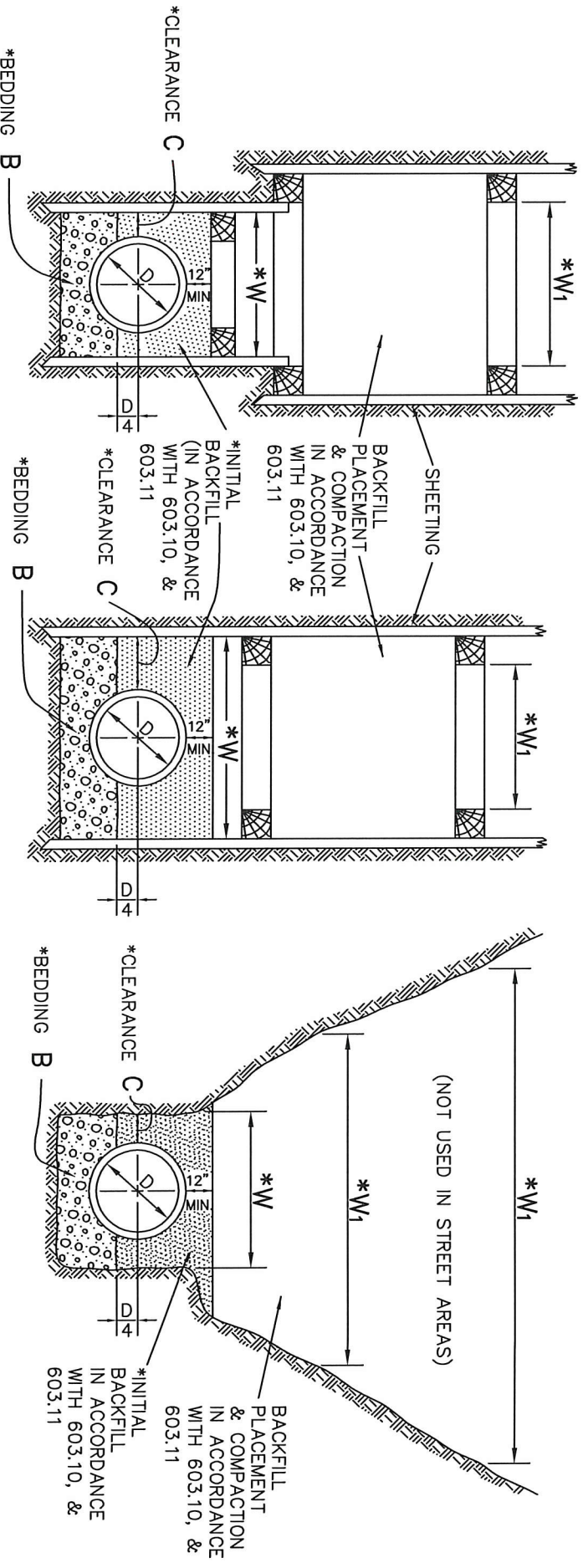

NOTE: ALL TRENCHES SHALL BE IN ACCORDANCE WITH OSHA STANDARDS (LATEST EDITION).

- W** SHALL NOT EXCEED 39 INCHES FOR 8 TO 21 INCH DIAMETER CONDUITS, OR THE GREATEST OUTSIDE DIAMETER PLUS 4 TIMES THE SHELL THICKNESS FOR CONDUITS 24 INCH DIAMETER AND OVER.
- C** SHALL BE NOT LESS THAN 6 INCHES AT THE POINT OF GREATEST OUTSIDE DIAMETER ON CONDUITS UP TO AND INCLUDING 60 INCH DIAMETER. SHALL BE NOT LESS THAN ONE SHELL THICKNESS AT THE POINT OF GREATEST OUTSIDE DIAMETER ON 66 INCH DIAMETER AND OVER.
- W₁** MAY BE EQUAL TO **W**, OR CAN BE MODIFIED AS GOVERNED BY SURFACE OR SUB-SURFACE CONDITIONS.

- B** CLASS OF MATERIAL AND DEPTH OF BEDDING UNDER CONDUIT:
 - 6 INCHES OF BANK RUN GRAVEL WITH NOT MORE THAN 5% CLAY OR SILT BY WEIGHT AND FREE FROM AN EXCESSIVE AMOUNT OF DELETERIOUS MATERIAL WITH THE FOLLOWING GRADATION:
 - 100% PASSING A 1-INCH SIEVE; NOT MORE THAN 25% PASSING A 1/4-INCH SIEVE; AND NOT MORE THAN 5% PASSING A NO. 50 SIEVE, FOR CONDUITS 6 TO 24 INCHES IN DIAMETER.
 - 6 INCHES OF NO. 57 CLEAN WASHED GRAVEL WITH 100% PASSING A 1-INCH SIEVE FOR CONDUIT 27 TO 60 INCHES IN DIAMETER.
 - 8 INCHES OF NO. 2 GRAVEL FOR CONDUIT LARGER THAN 60 INCHES IN DIAMETER.

* PLASTIC PIPE SHALL BE INSTALLED IN FULL COMPLIANCE WITH ASTM D-2321, LATEST EDITION, EXCEPT AS MODIFIED BY 603.018 AND FURTHER MODIFIED THAT ALL BEDDING SHALL PASS A 1-INCH SIEVE. CLASS I AND CLASS II BEDDING AND INITIAL BACKFILL SHALL BE USED AS FOLLOWS:

CLASS I MATERIAL SHALL BE USED WHEN THE DEPTH OF COVER ON THE CONDUIT IS BETWEEN 14 FEET AND 35 FEET.

CLASS II MATERIAL SHALL BE USED WHEN THE DEPTH OF COVER ON THE CONDUIT IS 14 FEET OR LESS.

THE
METROPOLITAN SEWER DISTRICT
OF
GREATER CINCINNATI
**CONTROL DIMENSIONS FOR
TYPICAL TRENCHES
FOR CONDUITS**

NO SCALE
DATE: DEC. 2010
APPROVED: *Ralph J. Johnson*
SEWERS CHIEF ENGINEER

ACC. NO. 49032

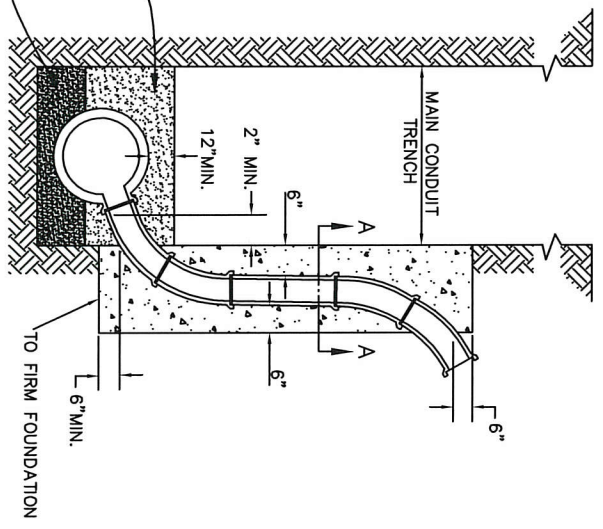
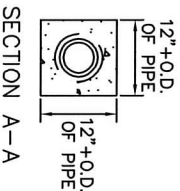
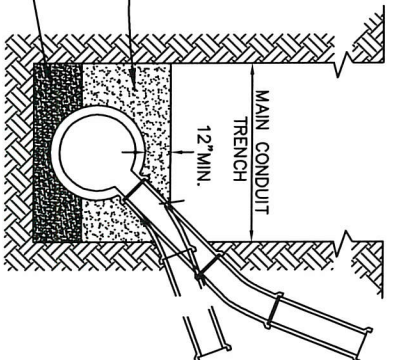
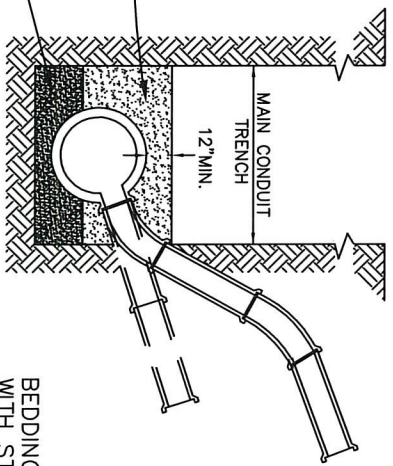
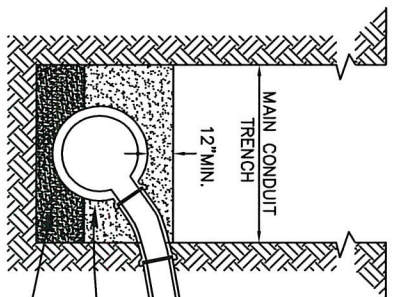

BACKFILL IN ACCORDANCE WITH STANDARD DRAWING ACC. NO. 49032

BACKFILL IN ACCORDANCE WITH STANDARD DRAWING ACC. NO. 49032

NOTE:
 STACKS SHALL BE BUILT OF CONCRETE LAID UP IN 1:2 PORTLAND CEMENT MORTAR, OR ALTERNATIVE CONSTRUCTION OF 6" OF CLASS "E" CONCRETE.
 ALL BENDS SHALL BE 30', OR 22 1/2' FOR PVC PIPE, AS NOTED.
 SEE ACC. NO. 49060 FOR INSTALLATION OF BUILDING SEWER LATERAL.

THE
 METROPOLITAN SEWER DISTRICT
 OF
 GREATER CINCINNATI
TYPICAL
BUILDING SEWERS AND STACKS

NO SCALE
 DATE: JUNE, 2009
 APPROVED: *[Signature]*
 SEWERS CHIEF ENGINEER

ACC. NO. 49033

INSTRUCTIONS

1. Installation of Building Sewers shall be done in accordance with M.S.D. Rules and Regulations.
2. Building Sewers are to be laid perpendicular to the main sewer direction of flow, spring line to spring line, and within produced property lines.
3. No deviation from instructions on the sewer permit will be permitted without permission from M.S.D.
4. Install bends as necessary on each side of the two-way cleanout so that the casting is flush with the ground.

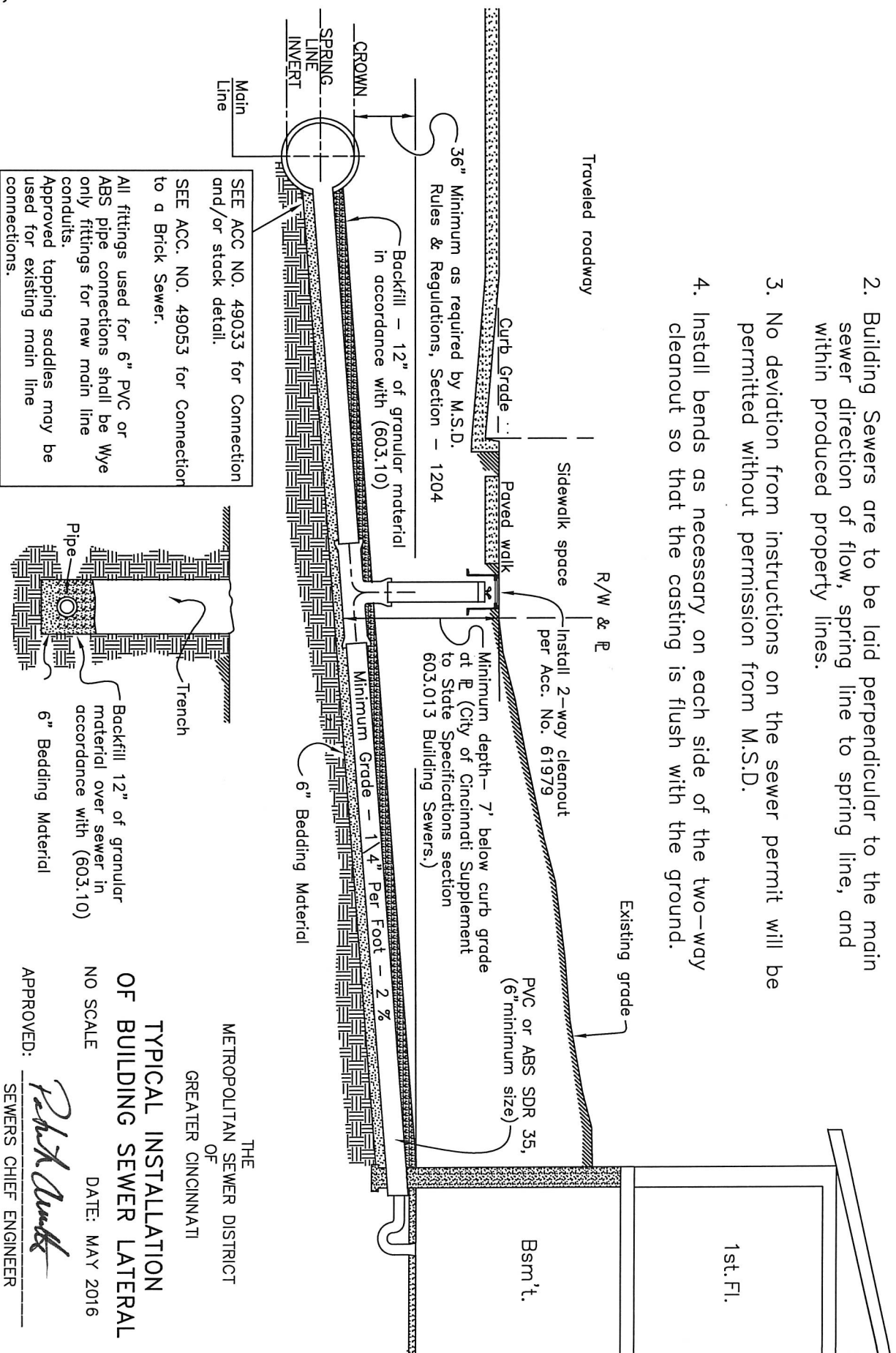

SEE ACC NO. 49033 for Connection and/or stack detail.
 SEE ACC. NO. 49053 for Connector to a Brick Sewer.
 All fittings used for 6" PVC or ABS pipe connections shall be only fittings for new main line conduits.
 Approved tapping saddles may be used for existing main line connections.

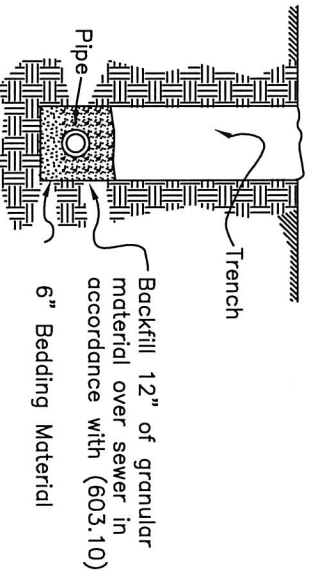

THE
 METROPOLITAN SEWER DISTRICT
 OF
 GREATER CINCINNATI

**TYPICAL INSTALLATION
 OF BUILDING SEWER LATERAL**

NO SCALE DATE: MAY 2016

APPROVED: *Robert A. Quirk*
 SEWERS CHIEF ENGINEER

ACC. NO. 49060

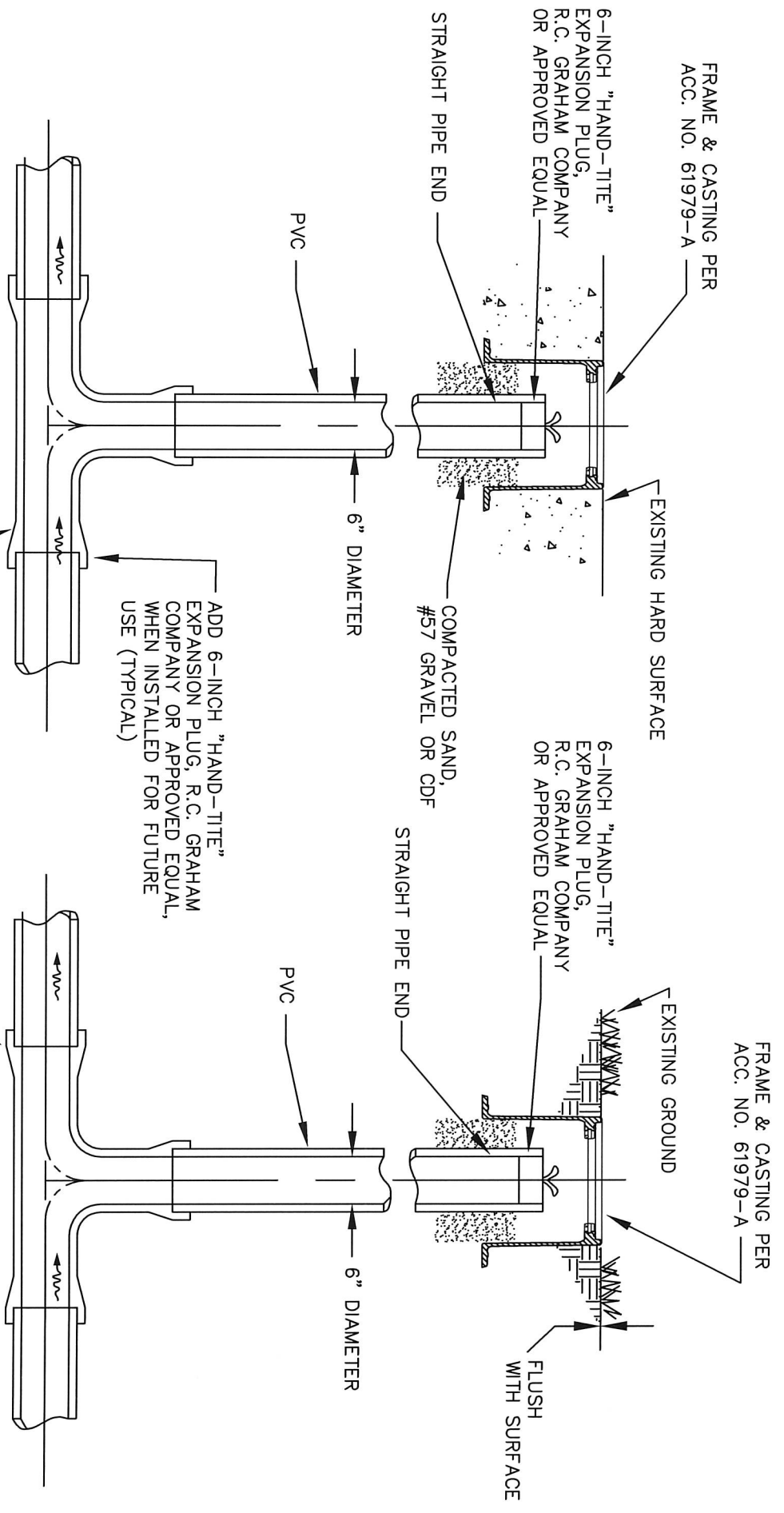

NOTES:
 ALL JOINTS SHALL BE FLEXIBLE ELASTOMERIC SEALS, ASTM D-3212
 CLEANOUTS SHALL BE PLACED EVERY 200 FEET, AND AT BENDS 45' OR GREATER

6"X6"X6" TWO WAY CLEANOUT
 PLASTIC TRENDS PART # G1006,
 MULTI-FITTINGS PART # 043708
 OR EQUAL

THE
 METROPOLITAN SEWER DISTRICT
 OF
 GREATER CINCINNATI
 STANDARD
 TWO WAY CLEANOUT
 FOR BUILDING SEWERS

NO SCALE
 DATE: AUG. 2011
 APPROVED: *Ralph A. ...*
 SEWERS CHIEF ENGINEER

M.C. ACC. NO. 61979

Include payment for concrete collars, Type A and Type B under 602 Concrete Masonry, unless otherwise provided in the Contract.

Plug or seal new pipes where required, in accordance with the requirements outlined in 202.041 "Abandoned Sewers and Drainage Structures." Include payment for this work in the Contract unit price bid for the pertinent 603 Conduit Item.

603.013 Building Sewers. At the property owner's sole cost, furnish all material and labor required to install the building sewers from either an existing sewer that is to remain or to a proposed carrier sewer, to a point beyond the limits of roadway construction.

Cooperate with the property owner to give ample opportunity to extend sewer connection from the existing sewer to a point beyond roadway construction limits. Include cost in the Contract unit price bid for the various 603 Conduit Items.

Replace all existing building sewers including; sanitary, yard, roof, basement or other similar pipe drains now in use, that are disturbed because of the improvement. Provide a satisfactory building sewer if the existing sewer is to be abandoned. Include payment for this work in the Contract unit price bid for the pertinent 603 Conduit Item.

Reconnect any unrecorded active connection to a sewer encountered in construction, to the existing or proposed sewers as directed by the Engineer. Include payment for this work in the Contract unit price bid for the pertinent 603 Conduit Item.

Construct building sewers, either by agreement with the property owner or under the Contract, in accordance with all applicable provisions of 603 of this Supplement.

Under usual conditions, lay the drain on a grade of not less than two percent, and where it crosses the property line, a minimum depth of seven feet (2.1 m) measured down from the curb grade to the flow line. Building sewers are deeper than the usual case cited above when it is intended that the building sewers serve low lying lots or deep cellars. The Contractor's attention is called to the requirements of the Cincinnati Building Code concerning building sewers.

In case the depth of the main sewer or the grade of the cellar is such that the depth of the house drain must be varied from the above figure of seven feet (2.1 m), special directions will be given regarding construction of the house drain. Construct building sewers as illustrated on Standard Drawing Acc. No. 49033. Excavate for the stack or riser beyond the sewer trench into firm ground in a trench or slot, which shall be a minimum of 20 inches square (500 mm x 500 mm).

Encase the stack or riser a minimum of six inches (150 mm) of Class QC1 concrete or four inches (100 mm) of brick masonry.

Defer backfilling building sewers until the Inspector obtains the elevation at the end of the building sewer or the vertical distance from the invert of the building sewer to the invert of the main sewer.

Seal the open ends of all unconnected building sewers with stoneware stoppers properly cemented into place. Mark the location of the ends of building sewers with wood strips not less than two inches by six inches (50 mm x 150 mm) in cross section and extending vertically from the end of the drain to a point 24 inches (610 mm) above the sidewalk grade. If at any time during construction the wood strips are broken or not apparent, uncover and replace them. When the sidewalk spaces and slopes are fine graded, cut strips to two inches (50 mm) below the finished grade. When the sewer branches are installed as part of a private improvement, as in the development of a subdivision, install the wood strips as above and protect in place until final inspection has been made of the improvement, at which time they may be cut down to ground level.

603.014 T and Y Branches. Construct straight pipe with T-branches where directed by the Engineer in strict accordance with the provisions of Section 603 of this Supplement. In laying the pipe, incline T-branches upward at an angle of about 45 degrees. Seal unconnected T-branches with stoneware stoppers properly cemented into place or seal using a stub and cap.

Keep an accurate record of the locations of all T-branches and furnish to the Engineer upon request.

The use of a Y-branch is encouraged when it is necessary that a branch leave the main sewer at an angle of more than 20 degrees from the perpendicular. When there is a head end manhole at the terminus of a street requiring several branches to enter the sewer at various angles, the use of Y-branches will be required. Do not connect building sewers to a manhole unless the Engineer has granted specific permission. Enter the sewer through the bench the same as other sewers, when such permission is granted.

Use wye fittings or approved saddles for all six inch (150 mm) connections to plastic pipe.

603.015 Bends. Install vitrified clay, plastic, or concrete bends, curves and elbows where required or as directed in laying or reconnecting building sewers and in the construction of stacks. Furnish and install in strict conformance with the applicable provisions of 603 of this Supplement. Include payment for this work in the Contract unit price bid for the various 603 conduit items.

603.016 Plastic Pipe. Meet the applicable ASTM specification requirements in all Pipe Manufacturer certification. Provide the Inspector/Engineer with certification forms, together with a report of the test results with pipe deliveries. Include project name, location, Contractor, and the test lot number on certification forms. The Engineer approval is required for the lot size.

Suitably mark all pipe and fittings to provide manufacturer's name, lot or production number, ASTM designation, ABS or PVC, and nominal diameter. Label all pipe with a "home" mark. Fittings need not contain lot or production number.

Flexible manhole joints are used with this pipe type.

Payment for sewers constructed in tunnel is made in accordance with the provisions of the pertinent 603 Conduit item, and in addition, the price bid per linear foot covers and includes furnishing and placing sheeting and bracing or liner plates, tunnel shafts, and furnishing and placing concrete for tunnel backfill.

Add:

603.059 Video Taping of installed Sewers. This item shall be used for verifying the integrity and water tightness of the final installed main line sewers following the leakage and deflection testing. All storm, sanitary and combined main line sewers shall be video recorded after all backfill and restoration work has been completed. The videos shall be PACP compliant, and the submittals must adhere to MSD/SMU requirements.

603.06 Bedding.

Conform the conduit bedding to one of the classes specified. When no bedding class is specified, conform the conduit bedding to Class B.

Class A. Bedding - consists of a continuous concrete cradle conforming to the plan details.

Class B. Bedding - consists of a bed of granular material having thickness as shown on Standard Drawing Acc. No. 49032.

Shape the layer of bedding material to fit the conduit for at least ten percent of the vertical diameter of the conduit and shape recesses to receive the bell of bell-and-spigot pipe.

603.07 Laying Conduit. Lay the conduit in the center of the trench starting at the outlet end with the bell or groove-end laid upgrade. Ensure that the conduit is in contact with the bedding throughout its full length such that line and grade is maintained. Lay metal conduits according to one of the following methods:

- A. If the seam is longitudinally either riveted or welded, place the seam or weld at the spring line.
- B. If the metal pipe is fabricated helically (having a continuous seam running around the outside of the pipe), arrange the corrugations so the helix angle or twist is rotating downstream in the direction of the flow to increase hydraulic performance.

Maintain flows at all times until the new facilities are completed and in service. Maintain the flows through existing facilities to be replaced unless a temporary bypass conduit is used.

Construct the inlet and outlet ends of all conduit runs with pipe ends as normally fabricated by the manufacturer. If field cutting is necessary, locate the cut end at an interior joint within the run and provide a cradle, collar, or band to ensure a stable joint.

Construct a concrete collar on the last joint if field cutting is necessary to meet a structure or headwall.

Low Pressure Force Main (pumped laterals)

1. Hamilton County Health inspects from the building to the grinder pit. MSD will inspect from the grinder pit to the sewer main.
2. Piping passes the air test when it holds 5 PSI for 15 minutes.
3. Minimum depth of piping is 23"
4. Pipe must be encased in concrete in a creek bed or within 1 foot of another utility line.
5. Minimum pipe size in 1.25"
6. Gauge used for air test must have glass intact.
7. Pipe materials must be SDR21, Schedule 40, or flexible water line with a minimum pressure rating of 150 PSI.
8. All fittings must be pressurized.
9. All fittings must be glued.
10. Do not backfill until pipe is inspected.
11. Connections should use "Y" fittings.